

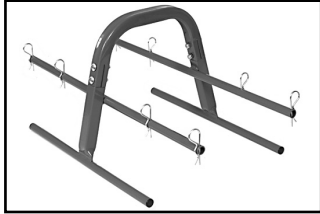

**Manufacturers of Quality
Electrical Products**

MH8010 Easy Lift Hand Caddy



Instruction Manual

Patent Pending

ELECTOR LLC

13 Wood Street
P.O. Box 26125
West Haven, CT 06516
Phone: 203-937-3029
Fax: 203-937-3028

For Parts, Accessories, or
Warranty Assistance, Please
Call 1-888-466-8600 x 106

One Year Limited Warranty

Elecor will repair or replace, at its expense and at its option, any Elecor product or accessory which in normal use has proven to be defective in workmanship or material, provided that the customer notifies his supplying distributor of the alleged defect within one year from the date of delivery. If requested by Elecor customer must provide reasonable opportunity to verify the defect by inspection. Elecor, will not be responsible for any asserted defect which has resulted from misuse, abuse, repair or alteration. Under no circumstances will Elecor be liable for incidental or consequential damages resulting from defective products. This warranty is Elecor's sole warranty and sets forth the customer's exclusive remedy with respect to defective products; all other

Safety Rules

This product was designed for certain applications only. Elecor strongly recommends that this product not be modified and/or used for any purpose other than that for which it was designed.

warranties, expressed or implied, whether of merchantability, fitness for purpose, or otherwise, are expressly disclaimed by Elecor.

Parts Or Warranty Assistance

All Elecor products and accessories are manufactured to high quality standards. To obtain additional information regarding your Elecor product or to obtain parts, accessories or warranty assistance, please contact customer service at 1-888-466-8600 x 106.

CAUTION

Use care when lifting the Easy Lift Hand Caddy.

Capacity

Eight spools each 7" in diameter by 5" wide OR four spools, each 7" diameter by 6"-10" wide.

Tools Required for Assembly



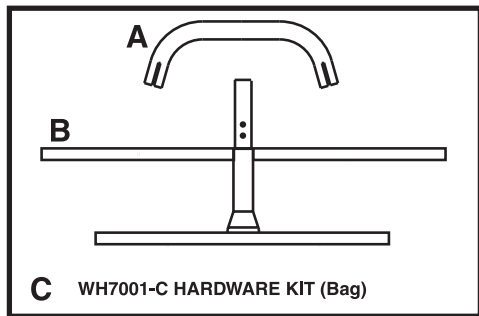

7/16-inch wrench or socket

Qty**Parts List**

- 1 A Handle
- 2 B Support Frame with Reel Shaft
- 1 C Hardware Kit MH8010-C

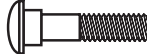
**Hardware**

The hardware for assembling the Easy Lift Hand Caddy is enclosed in the MH8010-C Hardware Kit bag. The kit contains the following items shown below.

Reference	Description	Qty
1	 1/4-20 X 1-1/4 CARRIAGE BOLT	4
2	 1/4 x 1/2 FLAT WASHER	4
3	 1/4-20 NYLON-INSERT LOCK NUT	4
4	 3 X 65 HITCH PIN CLIP	8

Assembly Instructions

- Place the Handle (A) onto the Support Frame connector. Make sure that the reel shaft is facing toward the inside as shown in Figure 1. Push down firmly until Handle (A) is seated against Support Frame (B). Repeat for the opposite side.

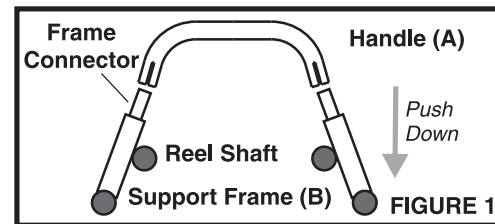

- Fasten Handle (A) to Support Frame (B) using the 1/4-20 x 1 1/4" Carriage Bolts (1), 1/4" x 1/2" Flat Washers (2), and 1/4 x 20 Nylon-Insert Locknuts (3) as shown in Figure 2. Repeat for the opposite side.

NOTE:

For best results, place the assembled wire caddy on a flat surface before tightening nuts.

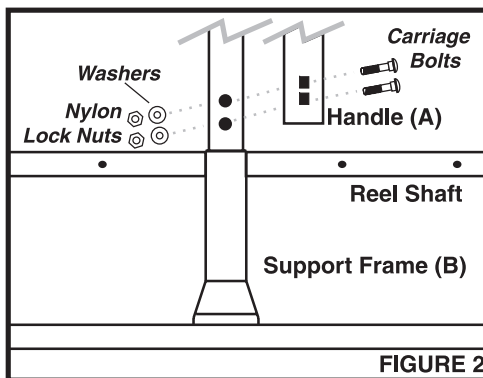

- Load wire spools onto Reel Shafts and secure using Hitch Pin Clips (4). Load spools from the inside out. For best results, when using multiple spools, balance the load equally on both sides.

